

(1 : 2)

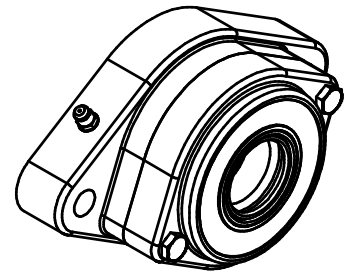
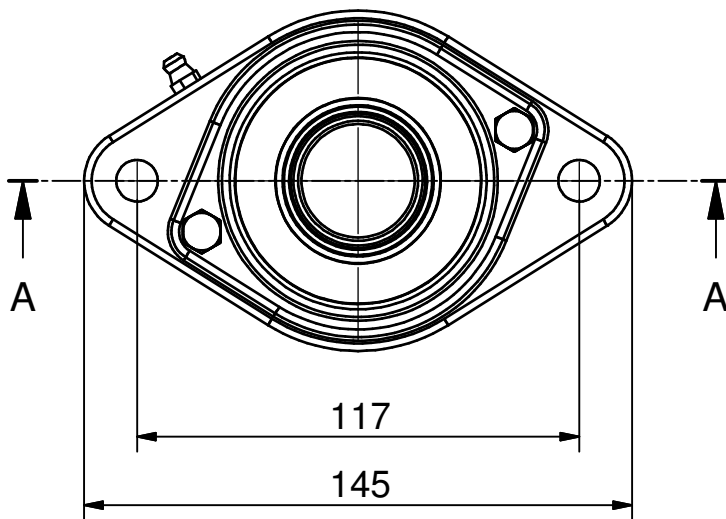
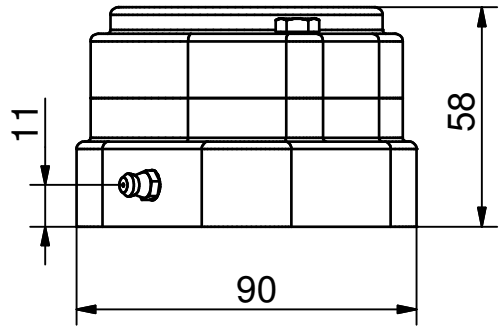
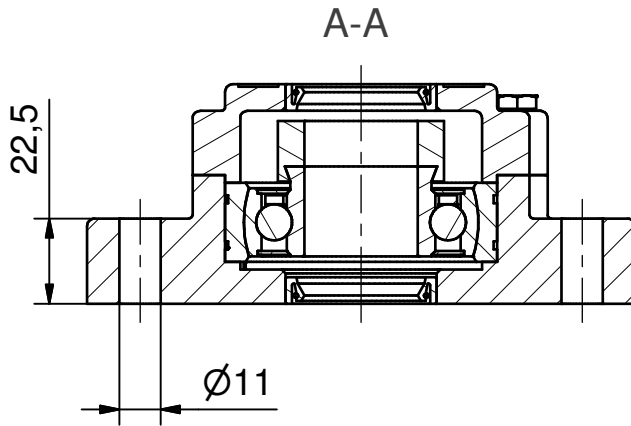

Denne tegning tilhører BJ-Gear A/S og må ikke kopieres eller benyttes uden tilladelse

BJ-Gear A/S

Niels Bohrs Vej 47
DK-8660 Skanderborg
Denmark
VAT No. DK 10166470

Phone +45 87 40 80 80
Fax +45 87 40 80 81
Email bj@bj-gear.com
Website www.bj-gear.com

Betegnelse:

Ø30 - 2huls Flangeleje (Åbent)

Projekt:

(A4)

Mål Uden tolerance: DS/ISO 2768-1 f

Dato: 17-01-2003

Konstruktør: TKC

Tegnings nr.:

NG30-F2-O 2D